

# BONES PLANTER 132x114x120

By Ludovica + Roberto Palomba



Bones is elegant by its slimness but at the same time strong by its conception. Its generous volume is alleviated for a subtle edge that makes it light. By the level of engineering Bones is fantastic, an invisible internal structure provides the necessary strength transmitting the weight from the base of the container to the base of the flowerpot for achieve to support the weight of any plant or tree. Bones is manufactured in resin of PE by means of the rotational molding technique and is available with multiples finished made in VONDOM.

View online: <https://www.vondom.com/products/57004A>

## Features

### Description

Pot made of polyethylene resin by rotational moulding. 100% Recyclable. Item suitable for indoor and outdoor use. Available in different finishes.

### Weight

44 Kg

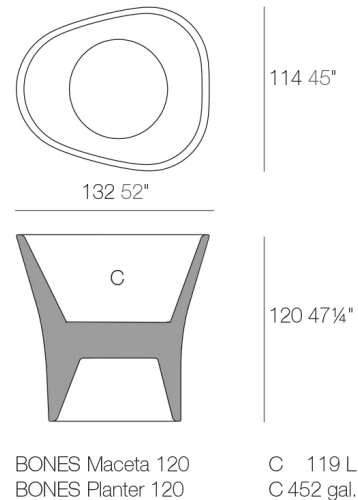

## Finishes

### SELF-WATERING

Ref. 57004R

Self-watering system included in all planters except those with basic finish

### BASIC

Ref. 57004A

Matt Polyethylene

### LACQUERED

Ref. 57004F

Lacquered Polyethylene

### RGBW LED

Ref. 57004L

Unit with internal lighting with RGBW LED technology and remote control unit for switching colors. Available only in matte ice white finish. Remote control included.

### RGBW LED DMX

Ref. 57004D

Unit with internal lighting with RGBW LED technology and remote control unit for switching colors. Also controlLED by DMX-1024 (wireless), enabling communication between one or more products simultaneously via the DMX transmitter (not included).

### RGBW LED BATTERY





























































Ref. 57004Y

**LIGHT**

Ref. 57004W

White internally lit unit with LED technology. Available only in matte ice white finish.

Unit with internal lighting with battery-powered RGBW LED technology. Includes charger and remote control for switching colors and charger. Available only in matte ice white finish.

COLOR	BASIC	LACQUERED / LACADO	LUZ	AUTORRIEGO
ICE				
WHITE				
BLACK				
BRONZE				
STEEL				
ANTHRACITE				
RED				
PISTACHIO				
ORANGE				
KHAKI				
NAVY				
TAUPE				
PLUM				
ECRU				
BEIGE				
CHAMPAGNE	